

## Vapor Pressures of Several Commercially Used Alkanolamines

Katarína Klepáčová,<sup>†</sup> Patrick J. G. Huttenhuis,<sup>\*,†</sup> Peter W. J. Derks,<sup>†</sup> and Geert F. Versteeg<sup>†,‡</sup>

<sup>†</sup>Procede Gas Treating B.V., P.O. Box 328, 7500 AH, Enschede, The Netherlands

<sup>‡</sup>Department of Chemical Engineering, University of Groningen, P.O. Box 72, 9700 AB, Groningen, The Netherlands

**ABSTRACT:** For the design of acid gas treating processes, vapor–liquid equilibrium (VLE) data must be available of the solvents to be applied. In this study the vapor pressures of seven frequently industrially used alkanolamines (diethanolamine, *N*-methylethanolamine, *N,N*-dimethylethanolamine, *N,N*-diethylethanolamine, diisopropanol-amine, 2-(2-aminoethoxy)ethanol, 2-amino-2-methyl-1-propanol) were measured in an ebulliometer. The VLE experiments were carried out at pressures between (1 and 400) kPa and at a maximum temperature of 453 K. The experimental data can be used to improve the thermodynamic models in gas treating processes and to determine the amine losses in the absorber and desorber.

### ■ INTRODUCTION

Aqueous solutions of alkanolamines are commonly used in the industry to remove acidic gases, primarily CO<sub>2</sub> and/or H<sub>2</sub>S, from industrial gas streams, like natural gas and flue gas. Accurate experimental vapor–liquid equilibrium (VLE) data are important parameters for the development of these gas treating processes. These experimental VLE data are required to regress the thermodynamic models used in process simulators for gas treating processes. In open literature, vapor pressure data of several commonly used alkanolamines are limited or even not available at all. In this paper, new vapor pressure data as determined in an ebulliometer are presented and compared with literature data, if possible.

### ■ EXPERIMENTAL SECTION

**Materials.** All chemicals used in this work were provided by Sigma Aldrich and Acros Organics and used without further purification. Detailed information on these chemicals can be found in Table 1.

**Experimental Apparatus.** The vapor pressure measurements were carried out in a modified Swietoslawski ebulliometer, which is described in detail by Rogalski and Malanowski.<sup>1</sup> In this work, an all-glass Fischer-Labodest apparatus was used and this setup can at present be used between pressures from (1 to 400) kPa and a maximum temperature of 453 K. The operation procedure is based on the principle of the “circulation method”. A schematic diagram of the apparatus is presented in Figure 1.

During a typical experiment, about 75 mL of solvent was initially placed gravimetrically in the ebulliometer. The pressure controller was set to the required value, and the liquid was heated by the submerged electrical heater (1) and partially evaporated. VLE is established inside the separation chamber (4). The equilibrium vapor is condensed and completely mixed with the liquid phase by flow turbulence (8–9). Both the circulated liquid and the condensed vapor are routed back to the heater to complete the normal circulation. Samples could be taken from both the liquid (7) as the condensed vapor phase (6). However, these sampling points were not used in this work, because only

pure components were tested. The pressure of the system was adjusted accurately with a combination of a vacuum pump and nitrogen supply. The temperature during the VLE experiments was detected with a precision of 0.1 K. The precision of the measurement of vapor pressure is estimated to be 0.5 % for the low pressure data (1 < *P* < 50 kPa) and 0.2 % for the high pressure data (50 < *P* < 400 kPa).

### ■ RESULTS

**Validation Experiments.** To test and validate the experimental setup, several validation experiments have been carried out with pure water and pure MEA. For these two components sufficient data is available in open literature for data comparison. The vapor pressure of water is studied very extensively, and scatter in the water vapor pressure is very limited. Accurate data for the water vapor pressure can be found at the National Institute of Standards and Technology (NIST) Web site.<sup>2</sup> In Table 2 the vapor pressure of water at different temperatures as determined in this work is compared with data from literature.<sup>2</sup>

Results from numerous studies of the vapor pressure of pure MEA have been reported in the open literature. Different experimental methods have been used to obtain the MEA vapor pressure for a wide range of conditions. Therefore, the alkanolamine MEA was chosen for an additional validation of the apparatus used in this study. In Table 3, the vapor pressure data of MEA as determined in this study are presented, and in Figure 2 a comparison with literature data is shown.

From Table 2 (water) and Figure 2 (MEA), it can be concluded that the VLE data determined during the above-described validation experiments are excellent in line with VLE data reported in open literature within the complete operating range of the VLE apparatus.

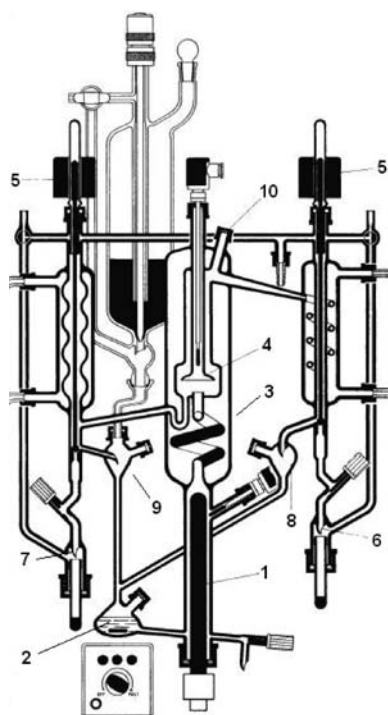
**Received:** November 23, 2010

**Accepted:** February 16, 2011

**Published:** March 09, 2011

Table 1. Details about the Chemicals Used in This Work

name		CAS No.	vendor	purity
water		7732-18-5	Acros Organics	HPLC grade
2-aminoethanol	MEA	141-43-5	Sigma-Aldrich	> 99.5 %
diethanolamine	DEA	111-42-2	Acros Organics	99 %
N-methylethanolamine	MMEA	109-83-1	Sigma-Aldrich	98+ %
N,N-dimethylethanolamine	DMMEA	108-01-0	Sigma-Aldrich	99.5 %
N,N-diethylethanolamine	DEMEA	100-37-8	Acros Organics	99 %
diisopropanolamine	DIPA	110-97-4	Acros Organics	99 %
2-(2-aminoethoxy)ethanol	DGA	929-06-6	Acros Organics	98 %
2-amino-2-methyl-1-propanol	AMP	124-68-5	Acros Organics	99 %



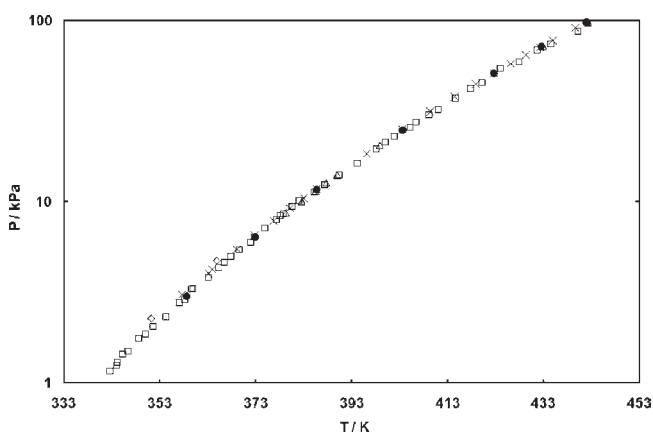
**Figure 1.** Schematic diagram of the Fischer Labodest apparatus (1, immersion heater; 2, mixing chamber; 3, lengthened contact path; 4, separation chamber; 5, magnetic sample valves; 6, condensed vapor sample takeoff; 7, liquid sample takeoff; 8, 9, circulation streams; 10, sampling port).

Table 2. Vapor Pressure of Water (This Work and Literature<sup>2</sup>)

water	this work	literature
<i>P</i> /kPa	<i>T</i> /K	<i>T</i> /K
11.9	322.6	322.4
30.9	343.0	342.9
69.9	362.9	363.0
100.0	372.4	372.8
150.0	383.9	384.5
270.2	402.3	403.1
400.3	415.8	416.8

Table 3. Vapor Pressure *P* of MEA as a Function of Temperature *T*

<i>T</i> /K	<i>P</i> /kPa
358.6	3.02
373.0	6.40
385.7	11.7
403.6	24.9
422.7	51.1
432.6	71.8
441.9	97.5



**Figure 2.** Experimental data of the vapor pressure *P* of MEA as function of temperature *T*: ●, this work; □, Matthews et al.;<sup>3</sup> △, McDonald et al.;<sup>4</sup> ◇, Nath and Bender;<sup>5</sup> ×, Tochigi et al.<sup>6</sup>

## EXPERIMENTAL RESULTS

In this section the new results of the (alkanolamine) vapor pressure experiments are presented and compared with available literature data. These vapor pressure data have been correlated with an Antoine correlation. The Antoine parameters for each alkanolamine are presented at the end of this section.  $\Delta P$  represents the absolute error between the measured experimental value and the Antoine correlation.

**Diethanolamine (DEA).** In Table 4, the measured VLE data of DEA are presented, and in Figure 3, a comparison with literature data is presented. The available VLE data of pure DEA in open literature show some scatter between the different authors. From Figure 3 it can be concluded that the new data are in line with other literature sources

Table 4. Vapor Pressure of DEA

T/K	$P_{\text{exp}}/\text{kPa}$	$\Delta P^a/\text{kPa}$
427.5	1.44	0.00
433.0	1.94	0.05
441.4	2.94	0.14
447.4	3.94	0.26
452.4	4.94	0.36

$$^a \Delta P = P_{\text{exp}} - P_{\text{calc}}$$

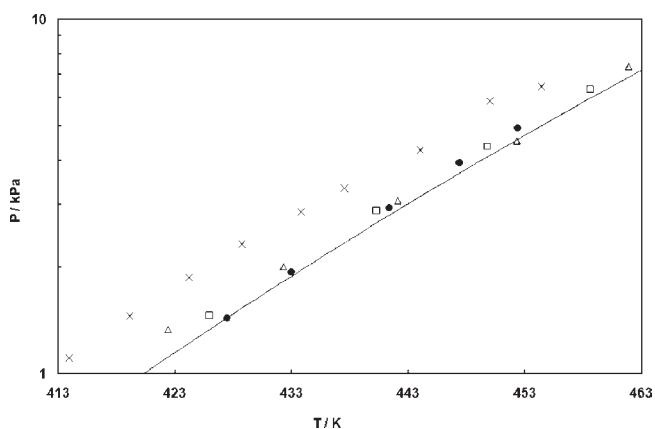


Figure 3. Vapor pressure  $P$  of DEA as function of temperature  $T$ : ●, this work; ×, Danov et al.;<sup>7</sup> □, Horstmann et al.;<sup>8</sup> △, Abedinzadegan Abdi and Meisen;<sup>9</sup> —, Antoine correlation.

Table 5. Vapor Pressure of MMEA

T/K	$P_{\text{exp}}/\text{kPa}$	$\Delta P^a/\text{kPa}$
341.8	1.94	-0.17
347.9	2.94	0.00
357.5	4.94	0.07
365.7	7.44	0.12
371.6	9.94	0.27
387.4	19.9	0.53
397.3	29.9	0.72
404.8	39.9	0.81
411.0	49.9	0.68
422.7	75.0	0.14
431.4	100.0	-0.71
437.3	120.0	-1.90
442.5	140.0	-3.42
444.8	150.0	-4.06
449.1	170.0	-5.48
451.1	180.0	-6.44

$$^a \Delta P = P_{\text{exp}} - P_{\text{calc}}$$

at the measured temperature range. Only the VLE data presented by Danov et al.<sup>7</sup> are not in line with the other literature data and the new VLE data. These experimental data have not been used for the determination of the constants of the Antoine correlation.

**N-Methylethanolamine (MMEA).** Two different literature sources were found for MMEA, and the newly measured vapor pressure data as presented in Table 5 are good in line with VLE data obtained from literature (refer to Figure 4).

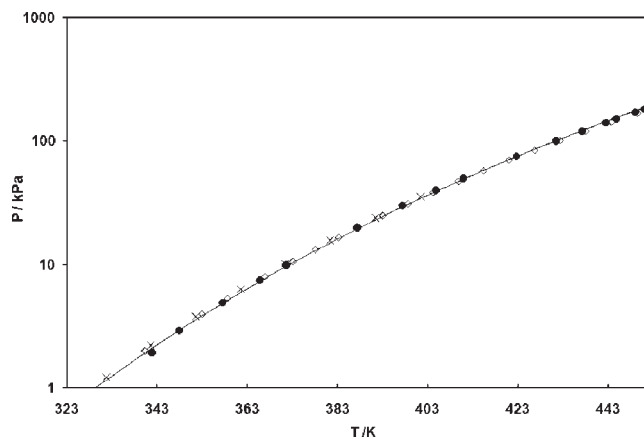


Figure 4. Vapor pressure  $P$  of MMEA as function of temperature  $T$ : ●, this work; ×, Noll et al.;<sup>10</sup> ◇, Steele et al.;<sup>11</sup> —, Antoine correlation.

Table 6. Vapor Pressure of DMMEA

T/K	$P_{\text{exp}}/\text{kPa}$	$\Delta P^a/\text{kPa}$
309.5	1.44	-0.07
320.8	2.94	0.08
330.4	4.94	0.21
338.5	7.44	0.36
344.7	9.94	0.49
360.9	19.9	0.90
371.2	29.9	1.23
385.3	49.9	1.53
397.6	75.0	1.48
406.8	100.0	1.09
413.1	120.0	0.35
420.9	150.0	-0.71
431.6	200.0	-3.41
440.4	250.1	-6.67
447.8	300.2	-10.45

$$^a \Delta P = P_{\text{exp}} - P_{\text{calc}}$$

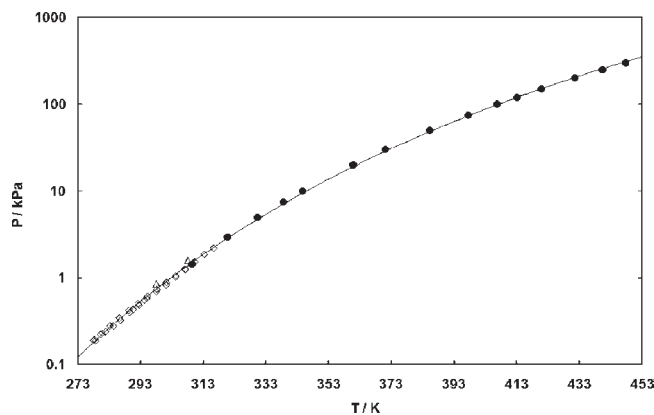


Figure 5. Vapor pressure  $P$  of DMMEA as function of temperature  $T$ : ●, this work; ◇, Kapteina et al.;<sup>12</sup> △, Touhara et al.;<sup>13</sup> —, Antoine correlation.

**N,N-Dimethylethanolamine (DMMEA).** Vapor pressure data for DMMEA were limited in literature. Only two sources

Table 7. Vapor Pressure of DEMA

T/K	$P_{\text{exp}}/\text{kPa}$	$\Delta P^a/\text{kPa}$
333.2	1.94	-0.11
340.7	2.94	-0.08
351.0	4.94	-0.03
359.8	7.44	0.03
366.5	9.94	0.07
383.9	19.9	0.29
395.1	29.9	0.46
410.5	49.9	0.82
423.9	75.0	1.16
434.0	100.0	1.34
440.9	120.0	1.27
443.9	130.0	1.29
449.5	150.0	1.25

$$^a \Delta P = P_{\text{exp}} - P_{\text{calc}}$$

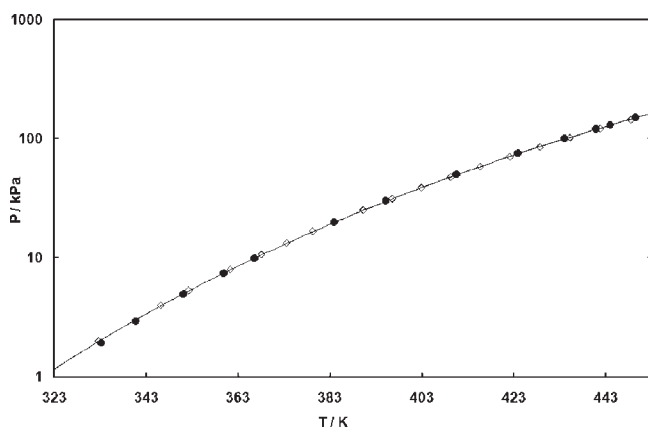


Figure 6. Vapor pressure  $P$  of DEMA as function of temperature  $T$ : ●, this work; ◇, Steele et al.;<sup>14</sup> —, Antoine correlation.

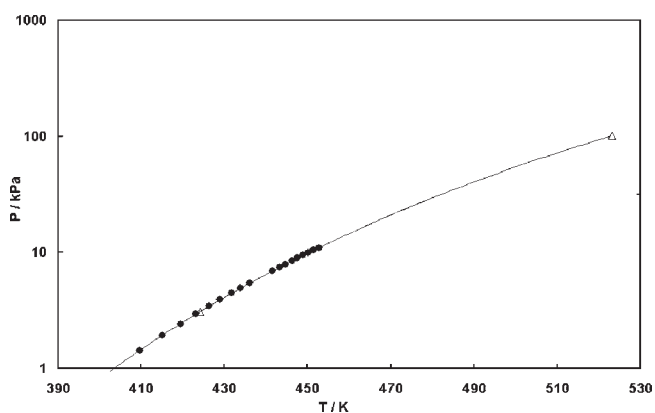


Figure 7. Vapor pressure  $P$  of DIPA as function of temperature  $T$ : ●, this work; △, CRC Handbook of Chemistry and Physics;<sup>21</sup> —, Antoine correlation.

(Kapteina et al.<sup>12</sup> and Touhara et al.<sup>13</sup>) were found, and both groups of authors measured the DMMEA vapor pressure only at low temperature up to 316 K. In this work new vapor pressure data were determined up to a temperature of 448 K as shown in Table 6. The new obtained data showed a good agreement

Table 8. Vapor Pressure of DIPA

T/K	$P_{\text{exp}}/\text{kPa}$	$\Delta P^a/\text{kPa}$
409.6	1.44	0.02
415.0	1.94	0.01
419.4	2.44	-0.01
423.0	2.94	-0.01
426.3	3.44	-0.03
429.0	3.94	0.00
431.7	4.44	-0.05
433.8	4.94	-0.01
436.1	5.44	-0.05
441.6	6.94	-0.02
443.3	7.44	-0.04
444.7	7.94	0.01
446.3	8.44	-0.03
447.5	8.94	0.05
448.9	9.44	0.01
450.1	9.94	0.08
451.3	10.4	0.10
451.4	10.4	0.03
452.7	10.9	0.02

$$^a \Delta P = P_{\text{exp}} - P_{\text{calc}}$$

Table 9. Vapor Pressure of DGA

T/K	$P_{\text{exp}}/\text{kPa}$	$\Delta P^a/\text{kPa}$
391.5	1.94	-0.07
399.4	2.94	-0.06
405.3	3.94	-0.02
410.1	4.94	-0.01
419.2	7.44	0.05
426.0	9.94	0.11
436.2	14.9	0.23
443.9	19.9	0.34
450.1	24.9	0.48

$$^a \Delta P = P_{\text{exp}} - P_{\text{calc}}$$

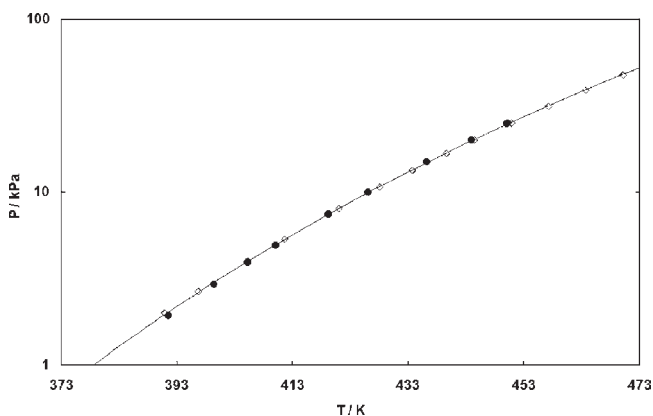


Figure 8. Vapor pressure  $P$  of DGA as function of temperature  $T$ : ●, this work; ◇, Steele et al.;<sup>15</sup> —, Antoine correlation.

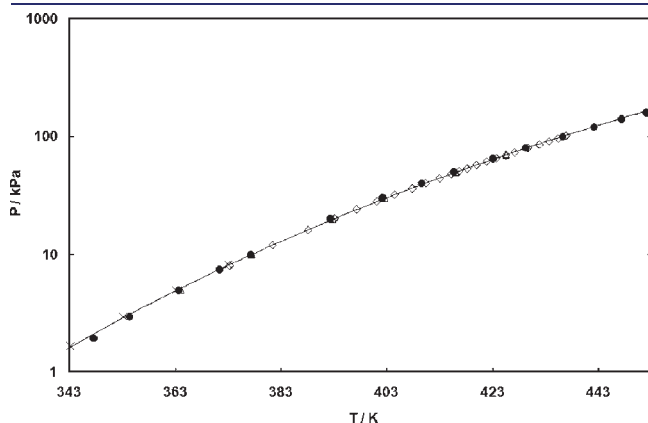
with the available low pressure data from literature (refer to Figure 5).

***N,N*-Diethylethanolamine (DEMEA).** For DEMEA only one literature source was available within the range (1 to 400) kPa (Steele et al.<sup>14</sup>). New vapor pressure data were obtained as shown in Table 7, and these data showed an excellent agreement with Steele et al.<sup>14</sup> over the entire range (Figure 6).

**Table 10. Vapor Pressure of AMP**

<i>T</i> /K	$P_{\text{exp}}$ /kPa	$\Delta P^a$ /kPa
347.5	1.94	-0.16
354.3	2.94	-0.14
363.6	4.94	-0.11
371.4	7.44	-0.02
377.2	9.94	0.08
392.3	19.9	0.57
402.1	29.9	0.91
409.5	39.9	1.14
415.6	49.9	1.22
423.0	65.0	1.19
429.2	80.0	1.05
436.2	100.0	-0.04
442.1	120.0	-0.79
447.3	140.0	-2.20
452.0	160.0	-4.23

$$^a \Delta P = P_{\text{exp}} - P_{\text{calc}}$$



**Figure 9.** Vapor pressure  $P$  of AMP as function of temperature  $T$ : ●, this work; ◇, Pappa et al.;<sup>16</sup> △, Barreau et al.;<sup>17</sup> ×, Belabbaci et al.;<sup>18</sup> —, Antoine correlation.

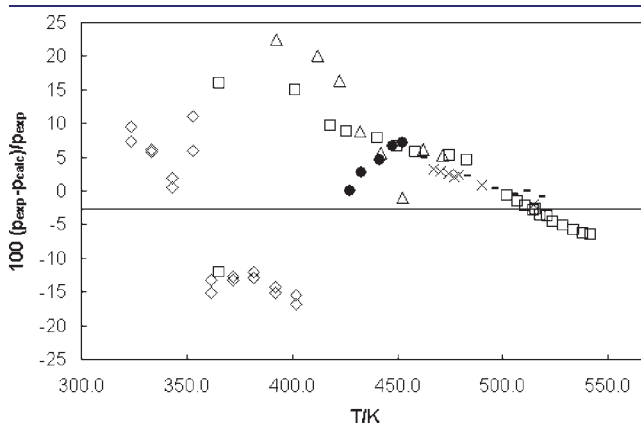
**Table 11. Antoine Constants for the Amines Used in This Study**

amine	$A$	$B$	$C$	range [K]	refs	no. of data points
DEA	18.27	-6440.9	-67.84	323–541	this work, 8, 9, 10, 4, 19	66
MMEA	17.17	-4778.2	-51.00	255–461	this work, 10, 11, 12, 13	93
DMMEA	15.62	-3900.7	-53.06	278–448	this work, 12, 13	47
DEMEA	14.54	-3573.4	-74.72	278–476	this work, 14, 12	67
DIPA	11.18	-2009.3	-224.15	410–453	this work	19
DGA	14.96	-3929.1	-115.94	391–719	this work, 15, 20	38
AMP	16.37	-4220.7	-77.46	293–452	this work, 16, 17, 18	53

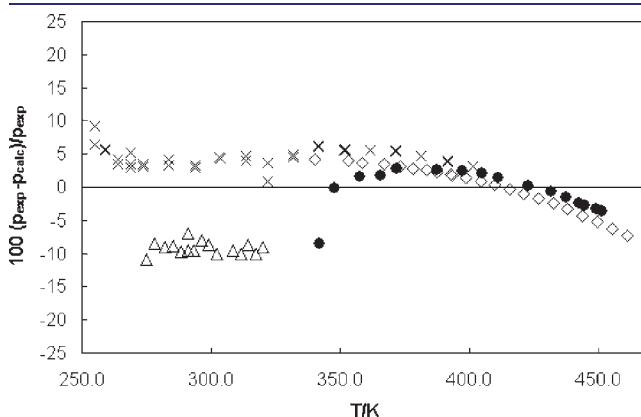
**Diisopropanolamine (DIPA).** No vapor pressure data for DIPA were reported in open literature, so the new obtained data as presented in Table 8 and Figure 7 could not be compared with other VLE data.

**2-(2-Aminoethoxy)ethanol (DGA).** Steele et al.<sup>15</sup> determined the vapor pressure of DGA between (390 and 516) K. The new obtained vapor pressure data for DGA are presented in Table 9 and compared with Steele et al.<sup>15</sup> in Figure 8. The new data are in line with the data of Steele.<sup>15</sup>

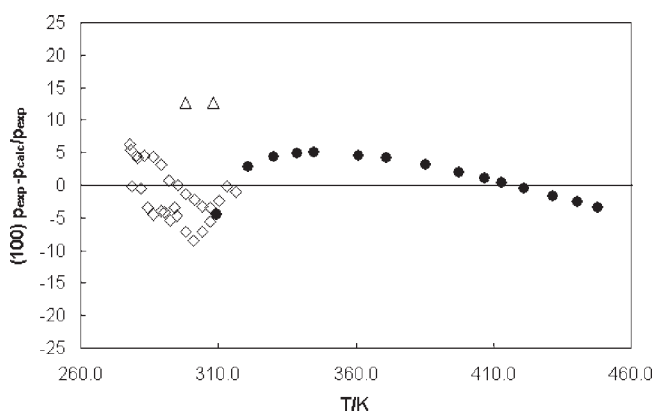
**2-Amino-2-methyl-1-propanol (AMP).** The vapor pressure of AMP was determined between (347 and 452) K, and the



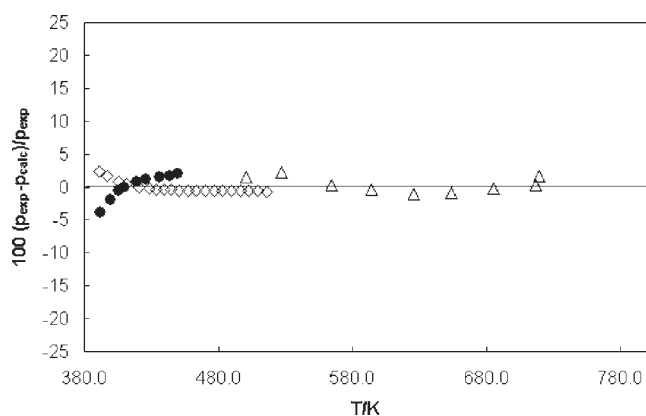
**Figure 10.** Deviation between calculated and experimental vapor pressure of DEA. ●, this work; ×, McDonald et al.;<sup>7</sup> □, Horstmann et al.;<sup>8</sup> △, Abedinzadegan Abdi and Meisen;<sup>9</sup> ◇, Noll et al.;<sup>10</sup> —, Antoine correlation.



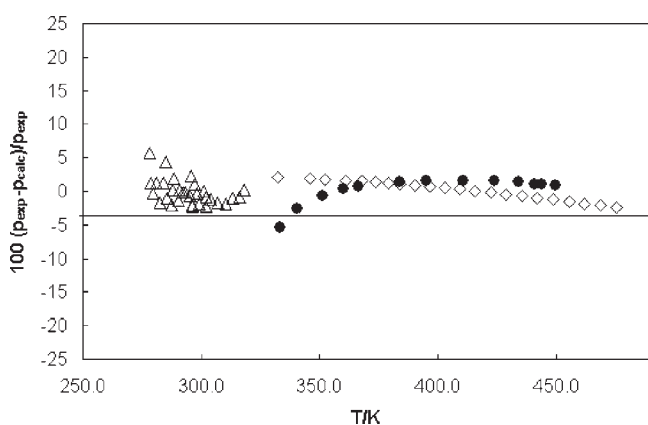
**Figure 11.** Deviation between calculated and experimental vapor pressure of MMEA. ●, this work; ×, Noll et al.;<sup>10</sup> △, Touhara et al.;<sup>13</sup> ◇, Steele et al.;<sup>11</sup> —, Antoine correlation.



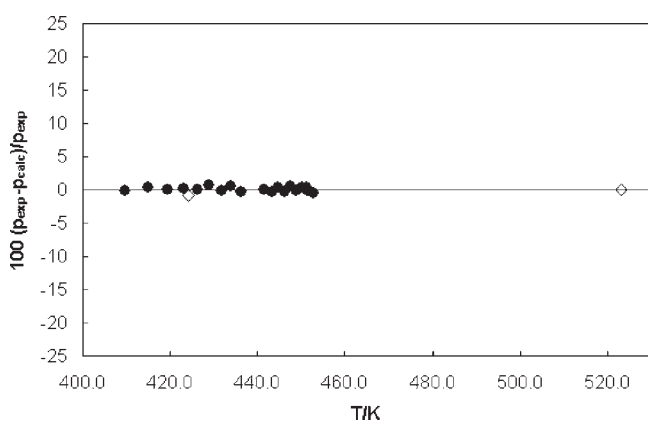
**Figure 12.** Deviation between calculated and experimental vapor pressure of DMMEA. ●, this work; △, Touhara et al.;<sup>13</sup> ◇, Kapteina et al.;<sup>12</sup> —, Antoine correlation.



**Figure 15.** Deviation between calculated and experimental vapor pressure of DGA. ●, this work; ◇, Steele et al.;<sup>15</sup> △, Von Niedernhausern et al.;<sup>20</sup> —, Antoine correlation.

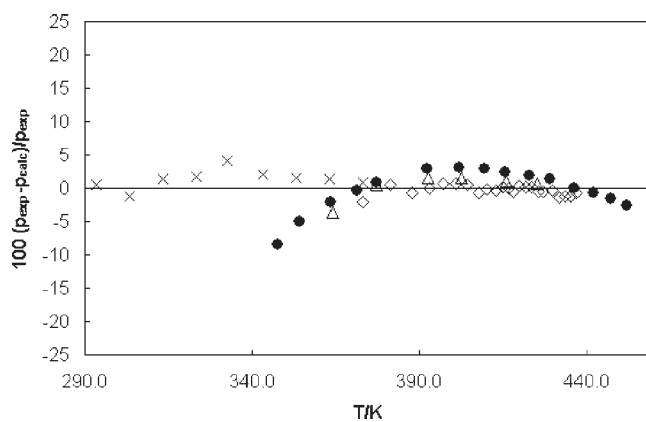


**Figure 13.** Deviation between calculated and experimental vapor pressure of DEMEA. ●, this work; △, Kapteina et al.;<sup>12</sup> ◇, Steele et al.;<sup>14</sup> —, Antoine correlation.



**Figure 14.** Deviation between calculated and experimental vapor pressure of DIPA. ●, this work; ◇, *CRC Handbook of Chemistry and Physics*;<sup>21</sup> —, Antoine correlation.

results of these experiments are presented in Table 10. These results were in good agreement with vapor pressure data reported in open literature (see Figure 9: Pappa et al.;<sup>16</sup> Barreau et al.;<sup>17</sup> Belabbaci et al.<sup>18</sup>).



**Figure 16.** Deviation between calculated and experimental vapor pressure of AMP. ●, this work; ◇, Pappa et al.;<sup>16</sup> △, Barreau et al.;<sup>17</sup> ×, Belabbaci et al.;<sup>10</sup> —, Antoine correlation.

**Antoine Correlations.** The vapor pressure data presented in this paper (new and existing) have been correlated with the following Antoine correlation:

$$\ln(P) = A + \frac{B}{C + T}$$

where

- $A$ ,  $B$ , and  $C$  are component specific constants;
- $T$  is the temperature in K;
- $P$  is the vapor pressure in kPa.

Nonlinear least-squares method is used to determine the several parameters of the Antoine correlation. In Table 11 the component specific Antoine constants, applicable temperature range, used references for parameter fitting, and number of used experimental data points are presented for each alkanolamine. In Figures 10 to 16 the relative errors of experimental values are given.

## CONCLUSION

In this work accurate vapor pressure (VLE) data of seven commercial used alkanolamines have been determined in an ebulliometer. The experiments have been carried out between vapor pressures of (1 and 400) kPa and a maximum temperature of 453 K. The setup and procedure were validated by determining the vapor pressure of water and MEA and compare these vapor pressure data

with widely available literature data. For all seven alkanolamines Antoine correlations were derived from the new and existing vapor pressure data. The newly obtained data can be used to improve the quality of thermodynamic models used in process simulators.

## AUTHOR INFORMATION

### Corresponding Author

\*E-mail: patrickhuthenhuys@procede.nl. Tel.: +31 53 711 25 08. Fax: +31 53 711 25 99.

### Funding Sources

This research is part of the CAPTECH programme. CAPTECH is supported financially by the Dutch Ministry of Economic Affairs under the regulation EOS (Energy Research Subsidy). More information can be found on <http://www.co2-captech.nl>.

## REFERENCES

- (1) Rogalski, M.; Malanowski, S. Ebulliometers modified for the accurate determination of vapour-liquid equilibrium. *Fluid Phase Equilib.* **1980**, *5*, 97–112.
- (2) *NIST Chemistry Webbook, NIST Standard Reference Database*; National Institute of Standards and Technology: Gaithersburg, MD, December 2003. <http://webbook.nist.gov/chemistry/>.
- (3) Matthews, J. B.; Sumner, J. F.; Moelwyn-Hughes, E. A. The Vapour Pressures of Certain Liquids. *Trans. Faraday Soc.* **1950**, *46*, 797–803.
- (4) McDonald, R. A.; Shrader, S. A.; Stull, D. R. Vapor Pressures and Freezing Points of 30 Organics. *J. Chem. Eng. Data* **1959**, *4*, 311–313.
- (5) Nath, A.; Bender, E. Isothermal Vapor-Liquid Equilibria of Binary and Ternary Mixtures Containing Alcohol, Alkanolamine, and Water with a New Static Device. *J. Chem. Eng. Data* **1983**, *26*, 370–375.
- (6) Tochigi, K.; Akimoto, K.; Ochi, K.; Liu, F.; Kawase, Y. Isothermal Vapor-Liquid Equilibria for Water + 2-Aminoethanol + Dimethyl Sulfoxide and Its Constituent Three Binary Systems. *J. Chem. Eng. Data* **1999**, *44*, 588–590.
- (7) Danov, S. M.; Matin, N. B.; Efremov, R. V.; Slashchinina, K. K. Vapor pressure of ethanolamines. *Zh. Fiz. Khim.* **1969**, *43*, 733–736.
- (8) Horstmann, S.; Mougín, P.; Lecomte, F.; Fischer, K.; Gmehling, J. Phase Equilibrium and Excess Enthalpy Data for the System Methanol + 2,2-Diethanolamine + Water. *J. Chem. Eng. Data* **2002**, *47*, 1496–1501.
- (9) Abedinzadegan Abdi, M.; Meisen, A. Vapor Pressure Measurements of Bis(hydroxyethyl)piperazine and Tris(hydroxyethyl)ethylenediamine. *J. Chem. Eng. Data* **1998**, *43*, 133–137.
- (10) Noll, O.; Valtz, A.; Richon, D.; Getachew-Sawaya, T.; Mokbel, I.; Jose, J. Vapour pressure and liquid densities of *N*-methylethanolamine, diethanolamine and *N*-methyldiethanolamine. *Int. Electron. J. Phys. Chem. Data* **1998**, *4*, 105–120.
- (11) Steele, W. V.; Chirico, R. D.; Knipmeyer, S. E.; Nguyen, A. Vapor Pressure, Heat Capacity, and Density along the Saturation Line, Measurements for Cyclohexanol, 2-Cyclohexen-1-one, 1,2-Dichloropropane, 1,4-Di-*tert*-butylbenzene, ( $\pm$ )-2-Ethylhexanoic Acid, 2-(Methylamino)ethanol, Perfluoro-*n*-heptane, and Sulfolane. *J. Chem. Eng. Data* **1997**, *42*, 1021–1036.
- (12) Kapteina, S.; Slowik, K.; Verevkin, S. P.; Heintz, A. Vapor Pressures and Vaporization Enthalpies of a Series of Ethanolamines. *J. Chem. Eng. Data* **2005**, *50*, 398–402.
- (13) Touhara, H.; Okazaki, S.; Okino, F.; Tanaka, H.; Ikari, K.; Nakanishi, K. Thermodynamic Properties of Aqueous Mixtures of Hydrophobic Compounds 2. Aminoethanol and its Methyl Derivates. *J. Chem. Thermodyn.* **1982**, *14*, 145–156.
- (14) Steele, W. V.; Chirico, R. D.; Knipmeyer, S. E.; Nguyen, A. Measurements of Vapor Pressure, Heat Capacity, and Density along the Saturation Line for Cyclopropane Carboxylic Acid, *N,N*-Diethylethanolamine, 2,3-Dihydrofuran, 5-Hexen-2-one, Perfluorobutanoic Acid, and 2-Phenylpropionaldehyde. *J. Chem. Eng. Data* **2002**, *47*, 715–724.
- (15) Steele, W. V.; Chirico, R. D.; Knipmeyer, S. E.; Nguyen, A. DIPPR Project 821 - vapor pressure of organic chemicals of industrial interest: the 1991 project results. Experimental Results for DIPPR 1990–1991 Projects on Phase Equilibria and Pure Component Properties. *DIPPR Data Series 2*; AIChE: New York, 1994; pp 154–173.
- (16) Pappa, G. D.; Anastasi, C.; Voutsas, E. C. Measurement and thermodynamic modelling of the phase equilibrium of aqueous 2-amino-2-methyl-1-propanol solutions. *Fluid Phase Equilib.* **2006**, *243*, 193–197.
- (17) Barreau, A.; Mougín, P.; Lefebvre, C.; Luu Thi, Q. M.; Rieu, J. Ternary Isobaric Vapor-Liquid Equilibria of Methanol + *N*-Methyldiethanolamine + Water and Methanol + 2-Amino-2-methyl-1-propanol + Water Systems. *J. Chem. Eng. Data* **2007**, *52*, 769–773.
- (18) Belabbaci, A.; Chiali-Baba Ahmed, N.; Mokbel, I.; Negadi, L. Investigation of the isothermal (vapour + liquid) equilibria of aqueous 2-amino-2-methyl-1-propanol (AMP), *N*-benzylethanolamine, or 3-dimethylamino-1-propanol solutions at several temperatures. *J. Chem. Eng. Data* **2010**, *42*, 1158–1162.
- (19) Daubert, T. E.; Jalowka, J. W.; Goren, V. Vapor Pressure of 22 Pure Industrial Chemicals. *AIChE Symp. Ser.* **1987**, *83* (256), 128–156.
- (20) Von Niederhausern, D. M.; Wilson, G. M.; Giles, N. F. Critical Point and Vapor Pressure Measurements for 17 Compounds by a Low Residence Time Flow Method. *J. Chem. Eng. Data* **2006**, *51*, 1990–1995.
- (21) Lide, D. R., Ed. *CRC Handbook of Chemistry and Physics*, 89th ed., internet version; CRC Press/Taylor and Francis, Boca Raton, FL, 2009.